

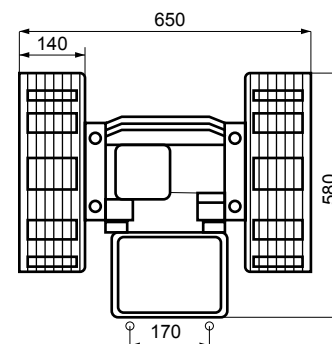

### Emergencia - Evacuación

Electrosirenas radiales

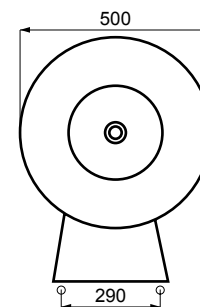
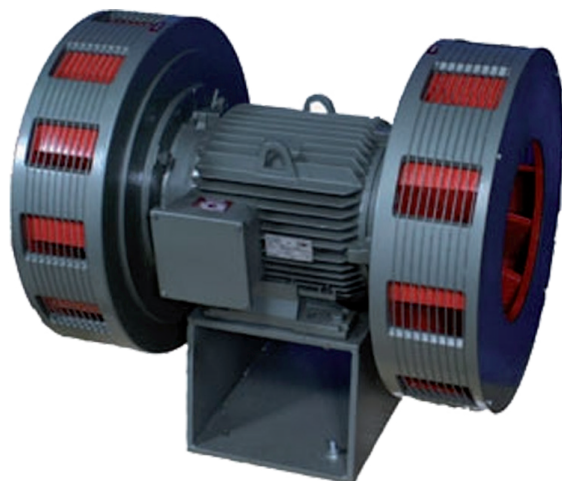

## K-SML15

Sirena electromecánica de motor trifásico. 145 dB

CÓDIGO	TENSIÓN V	FRECUENCIA Hz	POTENCIA MOTOR CV	CORRIENTE A	C. ARRANQUE A	CONSUMO Kw	FREC. ACÚSTICA Hz.
K-SML15AC380G	400 c.a.	50	10	18,75	122	7,5	560

Dimensiones: (Altura x Diámetro x Profundidad): 580 mm x 500 mm x 650 mm

Construcción: Aleación de aluminio



SE2

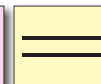
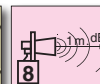
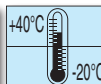
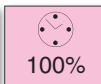

\*Opcional

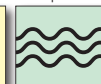

\* Sirena apta para emergencia y evacuación incorporando modulador ME15-LCD



## Variación teórica de la intensidad sonora respecto a la distancia del emisor (dB)

Es importante recordar que una Señal Acústica reduce en 6 dB su percepción sonora con el doble de la distancia

Ejemplo: 100 dB a 1 metro, significa 94 dB a 2 metros.  
94 dB a 2 metros, significa 80 dB a 10 metros.



DISTANCIA EN METROS

		1	2	3	5	10	20	30	50	100	200	300	500	1000	2000	3000	5000	
8	150	144	140	136	130	124	120	116	110	104	100	96	90	84	80	76	74	
	148	142	138	134	128	122	118	114	108	102	98	94	88	82	78	74	74	
	146	140	136	132	126	120	116	112	106	100	96	92	86	80	76	72	72	
	144	138	134	130	124	118	114	110	104	98	94	90	84	78	74	70	70	
	142	136	132	128	122	116	112	108	102	96	92	88	82	76	72	68	68	
	140	134	130	126	120	114	110	106	100	94	90	86	80	74	70	66	66	
	138	132	128	124	118	112	108	104	98	92	88	84	78	72	68	64	64	
	136	130	126	122	116	110	106	102	96	90	86	82	76	70	66	62	62	
	134	128	124	120	114	108	104	100	94	88	84	80	74	68	64	60	60	
	132	126	122	118	112	106	102	98	92	86	82	78	72	66	62	58	58	
	7	130	124	120	116	110	104	100	96	90	84	80	76	70	64	60	56	56
	6	128	122	118	114	108	102	98	94	88	82	78	74	68	62	58	54	54
		126	120	116	112	106	100	96	92	86	80	76	72	66	60	56	52	52
		124	118	114	110	104	98	94	90	84	78	74	70	64	58	54	50	50
		122	116	112	108	102	96	92	88	82	76	72	68	62	56	52	48	48
		120	114	110	106	100	94	90	86	80	74	70	66	60	54	50	46	46
118		112	108	104	98	92	88	84	78	72	68	64	58	52	48	44	44	
116		110	106	102	96	90	86	82	76	70	66	62	56	50	46	42	42	
114		108	104	100	94	88	84	80	74	68	64	60	54	48	44	40	40	
5	112	106	102	98	92	86	82	78	72	66	62	58	52	46	42	38	38	
	110	104	100	96	90	84	80	76	70	64	60	56	50	44	40			
	108	102	98	94	88	82	78	74	68	62	58	54	48	42	38			
	106	100	96	92	86	80	76	72	66	60	56	52	46	40				
	104	98	94	90	84	78	74	70	64	58	54	50	44	38				
	102	96	92	88	82	76	72	68	62	56	52	48	42					
4	100	94	90	86	80	74	70	66	60	54	50	46	40					
	98	92	88	84	78	72	68	64	58	52	48	44	38					
	96	90	86	82	76	70	66	62	56	50	46	42						
	94	88	84	80	74	68	64	60	54	48	44	40						
	92	86	82	78	72	66	62	58	52	46	42	38						
	90	84	80	76	70	64	60	56	50	44	40							
3	88	82	78	74	68	62	58	54	48	42								
	86	80	76	72	66	60	56	52	46	40								
	84	78	74	70	64	58	54	50	44	38								
	82	76	72	68	62	56	52	48	42									
	80	74	70	66	60	54	50	46	40									
	75	69	65	61	55	49	45	41										
2	70	64	60	56	50	44	40	36										
	65	59	55	51	45	39	35											
1																		



dB [A] 0 10 20 30 40 50 60 70 80 90 100 110 120 130 140 150

NIVEL DE SONIDO: 1 2 3 4 5 6 7 8