

INSTRUCTION & SERVICE MANUAL

AL105NSONTELFASH Telephone Alarm Horn & Xenon Strobe

- -25°C to +55C (-13°F to 131°F)
- 1.8Kg (3,96lb)
- CE & UKCA
- GOST-R approved: POCC GB-JB05-H00144
- Sounder Supply: Direct power from telephone line (REN 1)
- Beacon Supply: 230V ac (telephone initiated)
- IP66
- No. of tones: 3 Tone 1 Siren Tone Tone 2 Alternating tone Tone 3 Sweeping tone
- Volume control: Max. 105dB(A); Min. 90dB(A)
- Effect. range: 60m/197ft @ 1KHz
- Energy: 5 Joules (5Ws) Flash rate: 1Hz (60 fpm)
- Peak Candela: 500,000 cd – calculated from energy (J)
- Effect. Intensity cd:250 cd – calculated from energy (J)
- Peak Candela: 78,801 cd* – measured ref. to I.E.S.
- Effect. Intensity cd:196 cd* – measured ref. to I.E.S.

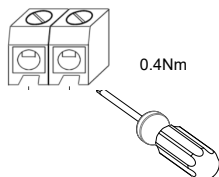
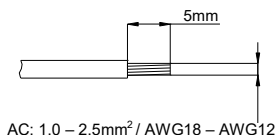
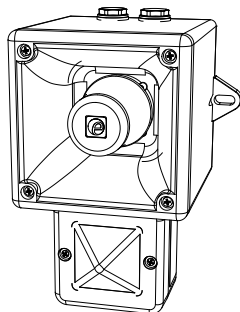

Attention: Installation must be carried out by an electrician in compliance with the latest codes and regulations.

Attention: L'installation doit être effectuée par un électricien conformément aux derniers codes et réglementations.

Achtung: Die Installation muss von einem Elektriker gemäß den neuesten Vorschriften und Bestimmungen durchgeführt werden.



Attenzione: L'installazione deve essere eseguita da un elettricista in conformità con i codici e le normative più recenti.

Atención: La instalación debe ser realizada por un electricista de acuerdo con los últimos códigos y regulaciones.

Atenção: A instalação deve ser realizada por um electricista de acordo com os códigos e regulamentos mais recentes.

Внимание: установка должна выполняться электриком в соответствии с последними нормами и правилами.

Attention: Disconnect from power source before installation or service to prevent electric shock



Attention: Débranchez-le de la source d'alimentation avant l'installation ou l'entretien pour éviter tout choc électrique.

Achtung: Vor Installation oder Wartung von der Stromquelle trennen, um einen Stromschlag zu vermeiden.

Attenzione: scollegare dall'alimentazione prima dell'installazione o dell'assistenza per evitare scosse elettriche.

Atención: desconéctelo de la fuente de alimentación antes de la instalación o el servicio para evitar descargas eléctricas.

Atenção: Desconecte da fonte de alimentação antes da instalação ou serviço para evitar choque elétrico

Внимание: отключите от источника питания перед установкой или обслуживанием, чтобы предотвратить поражение электрическим током.

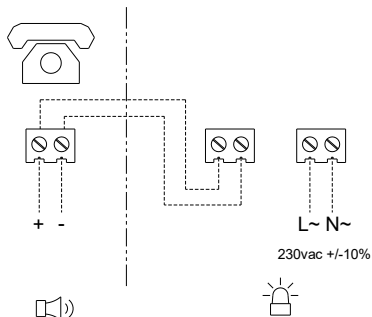

(See D247-06-001)

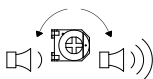

VOLUME CONTROL



TONE TABLE

Tone	Description		
Tone 1	Siren Tone		108dB(A)
Tone 2	Alternating tone		104dB(A)
Tone 3	Sweeping tone		106dB(A)

dB(A) output figures: +/-3dB(A)

INSTRUCTION & SERVICE MANUAL

AL105NSONTELFASH Telephone Alarm Horn & Xenon Strobe

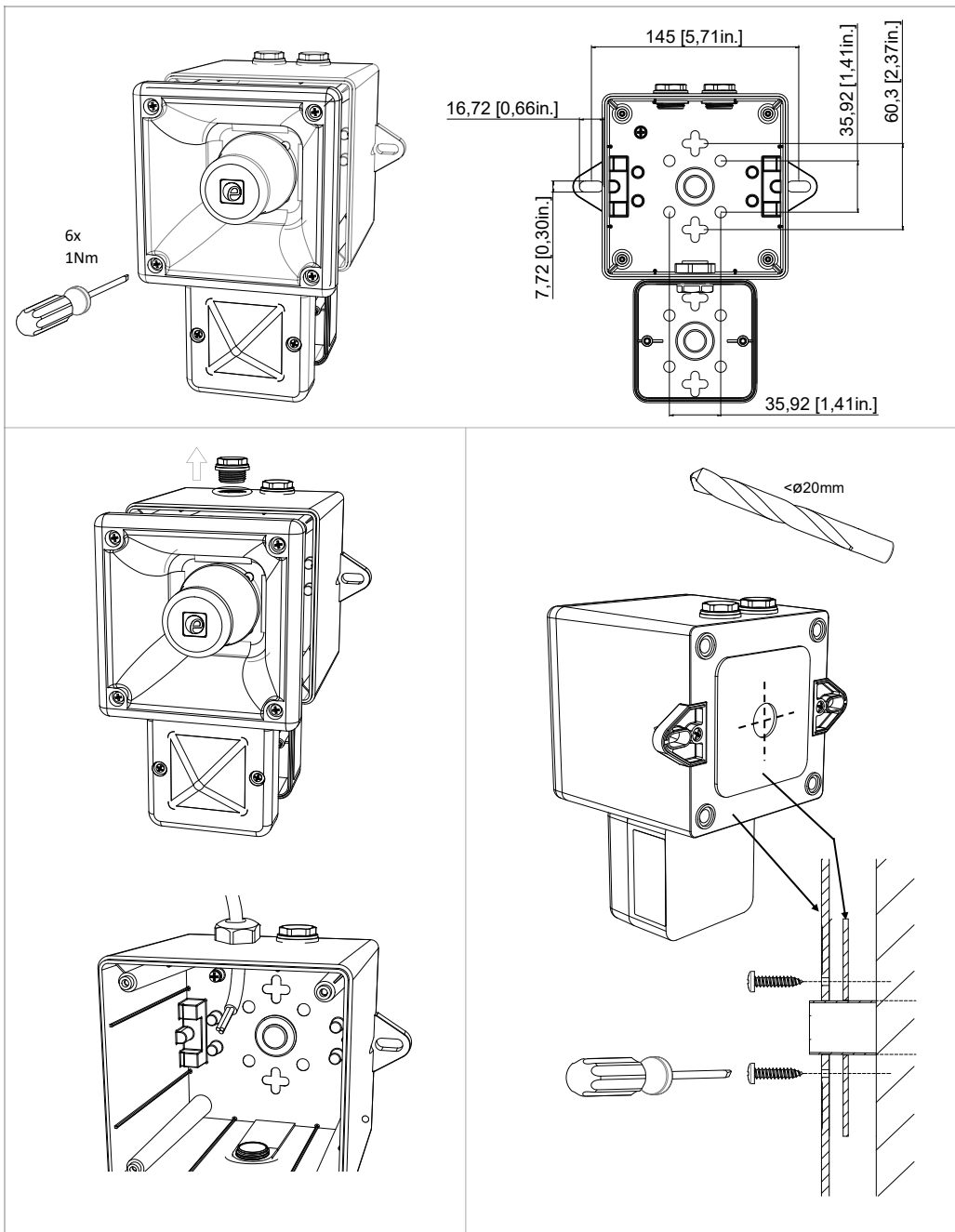





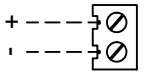

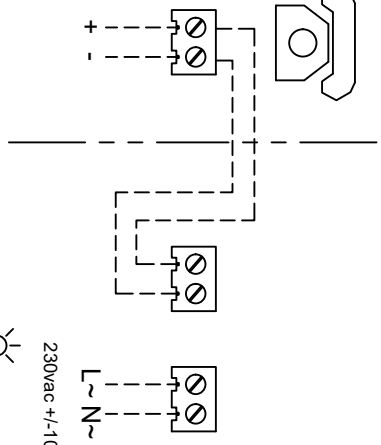
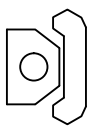

10	ISSUE	MOD No.	REASON - INITIAL - DATE
A	A	INTRODUCTION	JS-30/06/2021

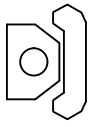
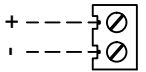
A100/ A105 SONTEL

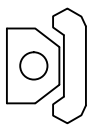
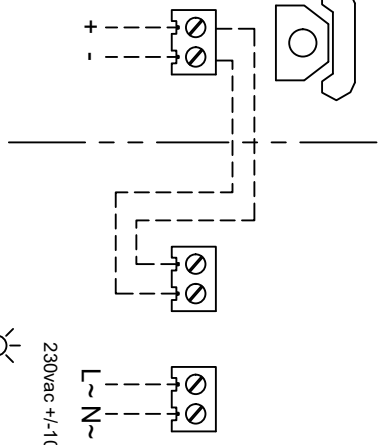

AL100/ AL105 SONTELFASH



A	1	2	3	4	5	6	7	8	9	10
B	A100/ A105 SONTEL									
C	AL100/ AL105 SONTELFASH									
D	  									
E	    <p>230vac +/-10%</p>									
F	  									
G	DRAWING TO BS8888:2000 GENERAL DIMENSIONS TO ISO1101:1983 ANGULAR DIMENSIONAL TOLS		DRAWN J. SPILLER DATE 30/06/2021		SURFACE FINISH		WEIGHT (KG)		THIS DRAWING AND ANY INFORMATION OR DESCRIPTIVE MATTER THEREIN IS COMMUNICATED IN CONFIDENTIAL SYSTEMS LTD. WHETHER THE WHOLE OR ANY PART MAY BE REPRODUCED OR TRANSMITTED IN ANY FORM OR BY ANY MEANS OR FOR ANY PURPOSES WITHOUT THE WRITTEN CONSENT OF CONFIDENTIAL SYSTEMS LTD. REGISTERED OFFICE: 11, ST. JOHN'S SQUARE, LONDON, E1 1JN. REGISTERED IN THE UK FOR PATENT PURPOSES. © AS PER LAYER DATE OF ISSUE SHOWN ABOVE	
G	STANDARDS SONTEL / FLASHTEL		CHECKED B. ISARD DATE 30/06/2021		MATERIAL		ALTERNATIVE MATERIAL		ALL DIMENSIONS IN MM IF IN QUOTE / ASK - DO NOT SCALE	
G			APPROVED R.N.POTTS DATE 30/06/2021						EUROPEAN SAFETY SYSTEMS LTD  11, ST. JOHN'S SQUARE MANCHESTER, M2 1JN LONDON W1J 1JH WWW.E2S.COM	
G									TITLE A100/AL100/A105/AL105 SONTEL / FLASHTEL WIRING SCHEMATIC SCALE NTS SHEET 1 OF 1 DRAWING NUMBER D247-06-001	

Page left Intentionally blank